

**BATTERY OPERATED PHOTOELECTRIC DETECTOR**  
**Smart Line™ series**

MODEL	DETECTION RANGE
SL-100 TNR	30m/100ft.
SL-200 TNR	60m/200ft.

**FEATURES**

- Battery operated detector
  - D size lithium battery or CR123A lithium battery (OPTION CRH-5)
- Simplified optical adjustment
  - Sniper View Finder with x2 magnification
- Avoids having to install a wireless transmitter in the photoelectric transmitter.
  - IR signal transmission technology transfers the low battery signal to the receiver
- Possible to connect the power and alarm cables to both the receiver and the transmitter or either of them
  - OPTION PCU-5
- Long battery life
- Battery saving function
- Intermittent output function
- Slim body design
- Easy to see vivid interior color for optical alignment
- IP65 waterproof structure
- Tamper function
- Indicator LED for an easy alignment
- Various options (Refer to page 4.) (BCU-5, CRH-5, PCU-5)

**1 INTRODUCTION**

**1-1 BEFORE YOUR OPERATION**

- Read this instruction manual carefully prior to installation.
- After reading, store this manual carefully in an easily accessible place for reference.
- This manual uses the following warning indications for correct use of the product, harm to you or other people and damage to your assets, which are described below. Be sure to understand the description before reading the rest of this manual.

<b>Warning</b>	Indicates a potentially hazardous situation which, if not avoided, will result in minor or moderate injury, or may result in serious injury or death. Additionally there may be significant property damage.
<b>Caution</b>	Indicates a potentially hazardous situation which, if not avoided, may result in minor or moderate injury or in property damage.

- ⊘ This symbol indicates prohibition. The specific prohibited action is provided in and/or around the figure.
- ⚠ This symbol requires an action or gives an instruction.
- ✓ This symbol indicates recommendation.

**Warning**

Do not use the product for purposes other than the detection of moving objects such as people and vehicles. Do not use the product to activate a shutter, etc., which may cause an accident.

Do not touch the unit base or power terminals of the product with a wet hand (do not touch when the product is wet with rain, etc.). It may cause electric shock.

Never attempt to disassemble or repair the product. It may cause fire or damage to the devices.

Do not use batteries that have different levels of power remaining (i.e., new and used batteries). Not observing the above may result in an explosion, leakage of electrolyte, emission of toxic gases or other outcomes that may be harmful to people and property.

[Handling of Batteries] Do not recharge, short circuit, crush, disassemble, exceed heat above 100°C (212°F), incinerate, or expose contents to water. Do not solder directly to the cell.

**Caution**

Do not pour water over the product with a bucket, hose, etc. The water may enter, which may cause damage to the devices.

Clean and check the product periodically for safe use. If any problem is found, do not attempt to use the product as it is and have the product repaired by a professional engineer or electrician.

**1-2 PRECAUTIONS**

Do not install the unit on an unstable surface.

Do not install the pole in a location where sufficient stability can not be ensured.

Do not install the unit in trees, leaves, or other objects that may swing in the wind and block the beam.

Do not install the receiver in a location where it is exposed to direct sunlight.

Do not allow the infrared beam from a another detector to reach the receiver.

Install the unit at a height where an object can be detected without fail.

The pole size should be 43 to 48 mm dia. (1.69 to 1.89 inch dia.).

Install the unit at least 1 m (3.3 ft.) away from the wall or fence that may be running parallel to the beam.

**1-3 PARTS IDENTIFICATION**

**Accessories >>**

- 4x20 self tapping for wall mounting (with rubber washer): 4
- Velcro tape: 1 set
- Cables: 3
- M4x16 screws for pole mounting (with rubber washer): 4
- Pole brackets: 2
- U-brackets: 2

**2 PREPARATIONS**

Detector power source	Battery type	Wireless transmitter power source	BATTERY			OPTION*			
			D-size	CR123A	For Wireless transmitter	CRH-5	BCU-5	PCU-5	
Wireless	D size	From detector battery	4 pcs.	-	No	-	1 set	-	
		From independence battery	4 pcs.	-	Need	-	-	-	
	CR123A	From detector battery	-	16 pcs.	No	2 sets	1 set	-	
		From independence battery	-	16 pcs.	Need	2 sets	-	-	
Wired	D size	From detector battery	2 pcs.	-	No	-	1 set	1 set	
		From independence battery	2 pcs.	-	Need	-	-	1 set	
		CR123A	From detector battery	-	8 pcs.	No	1 set	1 set	1 set
			From independence battery	-	8 pcs.	Need	1 set	-	1 set
	Both Transmitter and Receiver	-	From detector battery	-	-	No	-	1 set	2 sets
		-	From independence battery	-	-	Need	-	-	2 sets

\* Refer to "9 OPTIONS" on page 4.

# 3 INSTALLATION

## 3-1 SEPARATING

- 1 Remove the battery cover.
  - ① Loosen the battery cover lock screw.
  - ② Pull
- 2 Remove the main unit cover.
  - ① Loosen the main unit cover lock screw.
  - ② Pull
- 3 Remove the connectors.
- 4 Remove the main unit from the back box.
  - ① Turn the optical unit 90 degrees and loosen the screw.
  - ② Take the main unit out of the back box.
- 5 Remove the main unit mounting bracket.

**⚠ Caution**

- Do not place the main unit where it is exposed to direct sunlight. Doing so may cause damage to the product.

## 3-2 WALL MOUNTING

- 1 Using a screwdriver or similar tool, break the knockout position (×2) in the back box as shown.
 

Knockout position

WALL POLE (1) POLE (2)

Open the screw holes from the inside of the back box to the outside.
- 2 Mount the back box to the wall.
 

Side wall

Distance from the side wall: at least 1m

Pitch: 83.5 mm For connection to gang electric box

4×20 self tapping (with rubber washer)
- 3 Using Velcro tape, fix the wireless transmitters in the back box. For more information on wiring, see "3-5 WIRING" on page 3.
 

Velcro tape

Cut the supplied Velcro tape to an appropriate length and apply.

**Note>>**

  - When using BCU-4 (option), refer to BCU-4 manual.
- 4 Mount the main unit.
  - ① Attach the main unit mounting bracket to the back box.
  - ② Route the three connectors of the back box through the slits on the upper part of the main unit.
  - ③ Tighten the main unit fixing screw and turn the optical unit 90 degrees.

- 5 Attach the connectors.
- 6 Replace batteries.
 

< When using D size battery >

  - ① Open the battery plate in the direction of the arrow.
  - ② Insert the two batteries into their compartment. Ensure the positive terminals are facing toward the front.
  - ③ Close the battery plate.

3.9 VDC D size Lithium batteries

< When using CR123A battery >

  - ① Open the battery plate in the direction of the arrow.
  - ② Set CR123A in the CRH-5 and insert two CRH-5 into their compartment. Ensure the positive terminals are facing toward the front.
  - ③ Close the battery plate.
  - ④ Connect the CRH-5 male connectors to the female connectors of the battery plate.

CRH-5 3.0 VDC CR123A

**⚠ Warning**

  - Do not mix D size lithium batteries with CRH-5 batteries.
  - Do not mix batteries that have different levels of power remaining (i.e., new and used batteries or batteries of different manufacturers). Not observing the above may result in an explosion, leakage of electrolyte, emission of toxic gases or other outcomes that may be harmful to people and property.

**⚠ Caution**

  - Remove all batteries prior to replacing with new ones. If this is not followed, the low battery indicator LED will not reset and will continue to blink.

**Disposal method for batteries**

Dispose of used batteries in accordance with local government regulations/low and EU Battery Directive (2006/66/EU).
- 7 Referring to "4 SETTING" on page 3, perform the necessary settings.
- 8 Close the main unit cover.
  - ① Hook on the upper part of the back box.
  - ② Push the lower part of the main unit cover.
  - ③ Fasten the main unit cover lock screw.
- 9 Close the battery cover.
  - ① Close the battery cover.
  - ② Tighten the fixing screw for the battery cover.

Just fit

**⚠ Caution**

  - When closing the cover, be careful that the cables are not caught by the cover.

## 3-3 POLE MOUNTING

- 1 Using the guide below, break the knockout positions (×2) in the back box with a screwdriver.
 

Knockout position

WALL POLE (1) POLE (2)

Open the screw holes from the inside of the back box to the outside.
- 2 Fix the back box on the pole.
 

Side wall

Distance from the side wall: at least 1m

M4×20 screw (with rubber washer)

Pole 43 to 48 mm dia. (1.69 to 1.89 inch dia.)

Pole bracket U-bracket

Detector No. 1 Detector No. 2
- 3 Perform the wall mounting procedure of 3 to 9 on page 2.

Instruction condition	Knockout position	
	Detector No. 1	Detector No. 2
One detector	POLE (1)	-
Two detectors in opposing directions	POLE (1)	POLE (2)

**⚠ Caution**

- If you accidentally open an unnecessary knockout, be sure to fill the knockout. Not doing so may result in waterproof failure and malfunction of the product.



### 3-4 MOUNTING EXAMPLE AT PARTICULAR CASE

1 Avoid installing the transmitter and receiver facing each other through the corner of the cover.

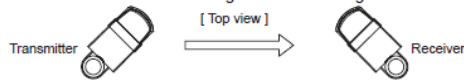

2 In doing this installation, the maximum detection range shall be half of the original detection range. (This is to compensate the attenuation of beam by the corner of the cover.)

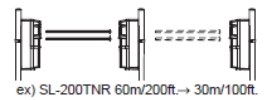

### 3-5 WIRING

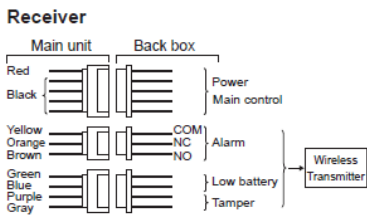

#### When connecting to BCU-5 (OPTION)

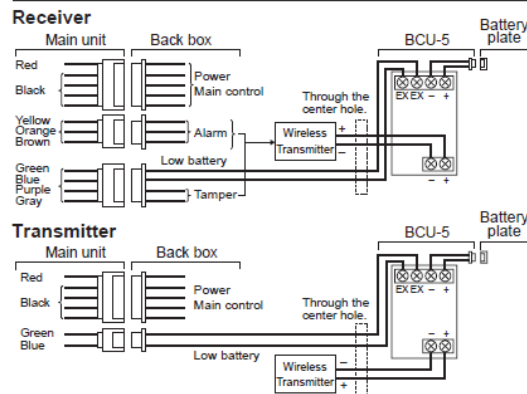

Attach the BCU-5 to the battery plate using double-sided adhesive tape.

- Be careful not to cover the power/low battery indicator LED.
- Select a location that does not interfere with the connector installation.

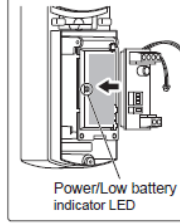

#### When connecting to PCU-5 (OPTION)

This unit used to enable wired operation. For more information on connecting, see PCU-5 manual.

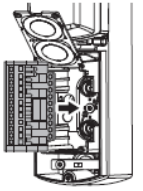

#### Note>>

Route the cables through the center hole.

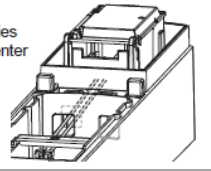

**Warning**

- When using BCU-5 (option), be sure to read the BCU-5 manual. Do not insert batteries into the wireless transmitter. Doing so may result in fire or explosion.

**Note>>**

- To monitor low battery levels separately for the receiver and the transmitter, install a wireless transmitter in each of them. When the low battery levels are monitored for both the receiver and transmitter centrally, install a wireless transmitter in only the receiver.
- If there is only an N.O. output on a wireless transmitter, the low battery output and tamper output cannot be used.
- The power supply can be shared between the back box and wireless transmitter by using BCU-5 (option).
- When using PCU-5 (option) with either only the transmitter or receiver, ensure the low battery signal is monitored. (Refer to PCU-5 manual.)

## 4 SETTINGS

### 4-1 FUNCTIONS

1 DIP SWITCH (factory default) Refer to "1-3 PARTS IDENTIFICATION".

**Receiver**

SELECTOR POSITION	ON	ON	ON	ON
SL-TNR	1	2	3	4

**Note>>**

- Do not press the tamper when you set the DIP switches. Otherwise the settings will not actually be changed.

2 BEAM INTERRUPTION ADJUSTMENT

Initial setting is at 50 ms for normal work. According to the speed of a supposed target you select one specific setting out of 4 steps. Set the beam interruption adjustment switches of the Receiver according to the speed of the human object to detect.

SELECTOR POSITION	ON	ON	ON	ON
SL-TNR	1	2	3	4
Running (50 msec)	[Diagram of a person running]			
Jogging (100 msec)	[Diagram of a person jogging]			
Walking (250 msec)	[Diagram of a person walking]			
Slow movement (500 msec)	[Diagram of a person moving slowly]			

3 BATTERY SAVING TIMER

The battery saving timer enforces 2 min intervals between alarm outputs. If the site of security involves a lot of traffic or in/out of people over a detection zone, wireless transmitters may wear out batteries quickly. The battery saving timer cancels alarms for two minutes after the initial output, preserving powers of wireless transmitters.

**Receiver**

ON	ON	ON	ON
OFF	OFF	OFF	OFF
SL-TNR	1	2	3

- Alarm output: 1 output/ 2 minutes

**Caution**

- Remove all batteries prior to replacing with new ones. If this is not followed, the low battery indicator LED will not reset and continue to blink.

4 INTERMITTENT OUTPUT FUNCTION

Intermittent output function enforces outputs to reset while beams continues to be interrupted. This function is effective if your wireless transmitters do not have supervised features to monitor relay status. Intermittent output function repeats alarms with intervals to let the system be aware of interrupted status.

**Receiver**

ON	ON	ON	ON
OFF	OFF	OFF	OFF
SL-TNR	1	2	3

- Alarm output: 1 output/ 1 minute

### 4-2 OPTICAL ALIGNMENT

Optical alignment is an important procedure to increase reliability. Be sure to take alignment step 1 through 2 described below to attain the maximum level of the output through the monitor jack.

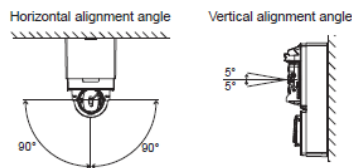

1 Look into the viewfinder and perform fine alignment of the horizontal and vertical angles using the alignment dial.

**Note>>** < How to look into the viewfinder >

**< Horizontal alignment >**

Turn the horizontal alignment dial by fingers to make alignment

**< Vertical alignment >**

Turn the vertical alignment dial with a screwdriver to make alignment

2 Checking the Indicator LED and fine alignment

**Checking of the illumination**

- After the rough alignment using the view finder, check the light receiving status by the Alarm/Level Indicator.

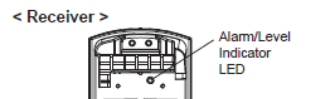

**Fine adjustment with monitor jack**

- After checking the receiving level of optical axis by using the alarm indicator, make sure to make fine alignment for both transmitter and receiver with voltmeter until it reaches maximum monitor output over "Good" level.

**< Receiver >**

Set the voltmeter range to 5 to 10VDC and connect the voltmeter probes ⊕ and ⊖ to ⊕ and ⊖ of the monitor jack respectively.

#### Note>>

- When making the adjustments by the monitor jack, be careful not to cover the optical unit with your hand, the voltmeter pin cord, etc.

Alarm/Level indicator LED	Beam interrupted		Beam received	
	ON	Fast blink	Slow blink	OFF
Adjustment level	Realign	Fair	Good	Excellent
Monitor jack output	0 V	0.1 VDC	2.0 VDC	2.8 VDC

#### Caution

- The Alarm/Level indicator LED is a supporting tool for easy alignment. Be sure to perform fine alignment to ensure the maximum output level through the monitor jack.
- The Alarm/Level indicator LED should only be used for rough alignment. For fine or good alignment, always use the monitor jack output level.

## 5 OPERATION CHECK

### 5-1 LED INDICATION

#### Alarm/Level indicator LED (Receiver only)

**Note>>**

- The operation of the Alarm/Level indicator LED will not change due to the battery saving timer setting. Whenever the beam is interrupted, the indicator will turn ON.

DETECTOR	LED
Beam Interruption	● ON (continue)
Beam not received sufficiently	● or ○
OFF	○ OFF

#### Power/Low battery indicator LED

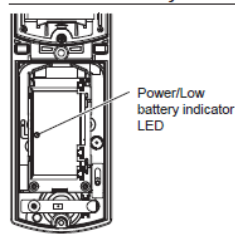

#### Receiver

BATTERY CONDITION	LED
Normal	● ON (continue)
Receiver is low battery	● ... ●
Transmitter is low battery	● ... ●
Both Receiver and Transmitter are low battery	● ... ●

#### Transmitter

BATTERY CONDITION	LED
Normal	● ON (continue)
Receiver is low battery	● ON (continue)
Transmitter is low battery	● ... ●
Both Receiver and Transmitter are low battery	● ... ●

## 5-2 OPERATION CHECK

After installation is complete, be sure to check the operation.

- 1 Make sure that the Alarm/Level indicator LED is OFF.  
If it is illuminated even when the beams are not blocked, make optical alignment again.
- 2 Check that the Power/Low battery indicator LEDs on both transmitter and receiver are ON.  
If the Power/Low battery indicator LED is blinking, the battery power is low. Replace with new batteries.
- 3 Conduct a walk test to check that Alarm/Level indicator LED on the receiver turns ON as the walker interrupts the beams.

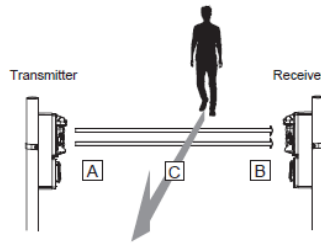

Be sure to conduct a walk test at the following three points:

- A. In front of the transmitter
- B. In front of the receiver
- C. At the mid point between the transmitter and receiver

The detector is installed properly when Alarm/Level indicator LED turns ON in the tests at all the three points.

## 6 TROUBLESHOOTING

PROBLEM	POSSIBLE CAUSE	CORRECTIVE ACTION
Power/Low battery indicator LEDs are not illuminated. (transmitter/receiver)	Reversed battery polarity.	Check the battery polarity.
Alarm is not output.	Reflection from the floor or wall.	Align beams away from the floor or wall.
	Beam has not been blocked.	Block all two beams.
When the beam is blocked, the "ALARM" indicator LED is illuminated but the alarm is not activated.	Signal line short-circuited	Check the wiring.
Alarm is activated even if the light is not blocked.	Interruption time is too short.	See "4-1 BEAM INTERRUPTION ADJUSTMENT" on page 3, set an appropriate interruption time.
	Surface of Transmitter/Receiver cover soiled.	Clean the cover (wipe the cover with a soft cloth dampened with water or diluted neutral detergent).
	Optical alignment was not performed properly.	See "4-2 OPTICAL ALIGNMENT" on page 3 and make realignment.
Batteries are running out too quickly.	Problem with tamper output.	Set the cover properly.
Frost, snow or heavy rain causes false alarm.	Optical alignment not optimized.	See "4-2 OPTICAL ALIGNMENT" on page 3 and make realignment.
Improper output	Problem with wiring.	Install the correct wiring.
Even if new batteries are used, Low battery indicator LED is ON.	Batteries are inactive condition.	Open and close the battery cover 20 times with two seconds intervals. After this, open the battery plate and then close it.

## 7 DIMENSIONS

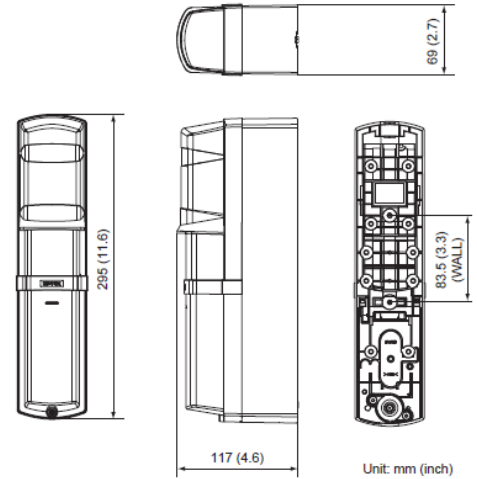

## 8 SPECIFICATIONS

Model		SL-100TNR	SL-200TNR
Maximum detection range		30 m/100 ft.	60 m/200 ft.
Maximum arrival distance		265 m/800 ft.	530 m/1740 ft.
Detection method		Twin infrared beam interruption detection	
Interruption time		Variable between 50/100/250/500 ms (4 steps)	
Power source		3.9 VDC D size lithium batteries (SB-D02HP manufactured by VITZROCELL)	Each Transmitter and Receiver: 2 units (3.0 VDC CR123A lithium batteries)
Current draw (stand by /at 25°C)	3.9 VDC	Total: Approx. 500 µA Transmitter: Approx. 200 µA Receiver: Approx. 300 µA	Total: Approx. 600 µA Transmitter: Approx. 300 µA Receiver: Approx. 300 µA
	3.0 VDC	Total: Approx. 600 µA Transmitter: Approx. 200 µA Receiver: Approx. 400 µA	Total: Approx. 700 µA Transmitter: Approx. 300 µA Receiver: Approx. 400 µA
Battery life **	SB-D02HP by VITZROCELL	Transmitter: Approx. 6 years Receiver: Approx. 5 years	Approx. 5 years
	CRH-5 (CR123A by Panasonic)	Transmitter: Approx. 1.5 years Receiver: Approx. 1 year	Approx. 1 year
Output	Alarm output	Form C-Solid State Switch: 3.9 VDC, 0.01 A	
	Alarm period	2 s (±1)	
	Low battery output	N.C. (Solid State Switch): 3.9 VDC, 0.01 A	
	Cover tamper output (Receiver)	N.C. (Solid State Switch): 3.9 VDC, 0.01 A Opens when the battery cover removed.	
Indicator LED	Alarm/ Level indicator (Receiver)	ON: Beam not received Blinking: Beam not received sufficiently OFF: Beam received	
	Power/ Low battery indicator (Transmitter and Receiver)	ON: Power ON Blinking: Voltage reduction OFF: Power OFF	
	Operating temperature	-20°C to +60°C (-4°F to 140°F)	
Operating humidity	95 % (max.)		
Alignment angle	±90° Horizontal, ±5° Vertical		
Dimension	H × W × D mm (inch): 295 (11.6) × 69 (2.7) × 117 (4.6)		
Weight	1200 g (Total weight of Transmitter + Receiver, excluding accessories)		
International protection	IP65		

Specifications and design are subject to change without prior notice.

\* The value is based on the condition that it is used within the ambient temperature range of 20 to 25°C.

\*\* Using batteries other than those recommended may shorten the battery life.

## 9 OPTIONS

### BCU-5 Battery Common use Unit (1 unit/set)

Share power source and low battery signals between the main unit and the wireless transmitter.

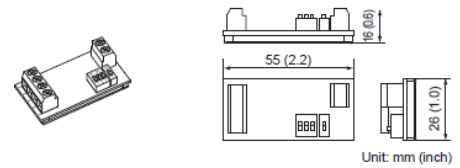

### CRH-5 CR123A Battery Holder (2 units/set)

Battery holder when using CR123A as a power source

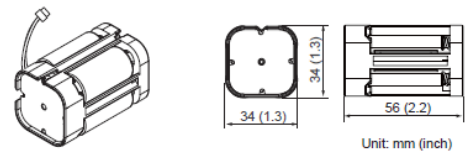

### PCU-5 Power Converter Unit (1 unit/set, battery is sold separately.)

Voltage convertor unit used to enable wired operation of the detector

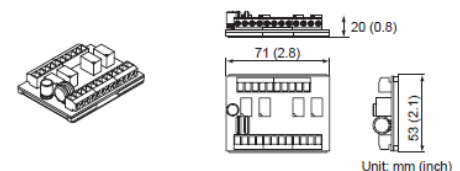

## NOTE

These units are designed to detect an intruder and activate an alarm control panel. Being only a part of a complete system, we cannot accept responsibility for any damages or other consequences resulting from an intrusion.

These products conform to the EMC Directive 2004/108/EC.



OPTEX CO., LTD. (JAPAN)  
URL: <http://www.optex.net>

OPTEX INC. (U.S.)  
[www.optexamerica.com](http://www.optexamerica.com)

OPTEX DO BRASIL LTDA. (Brazil)  
[www.optex.net/br/les/sec](http://www.optex.net/br/les/sec)

OPTEX (EUROPE) LTD. / EMEA HQ (U.K.)  
[www.optex-europe.com](http://www.optex-europe.com)

OPTEX TECHNOLOGIES B.V.  
(The Netherlands)  
[www.optex.eu](http://www.optex.eu)

OPTEX SECURITY SAS (France)  
[www.optex-security.com](http://www.optex-security.com)

OPTEX SECURITY Sp.z o.o. (Poland)  
[www.optex.com.pl](http://www.optex.com.pl)

OPTEX PINNACLE INDIA, PVT., LTD. (India)  
[www.optex.net/in/en/sec](http://www.optex.net/in/en/sec)

OPTEX KOREA CO.,LTD. (Korea)  
[www.optexkorea.com](http://www.optexkorea.com)

OPTEX (DONGGUAN) CO.,LTD.  
SHANGHAI OFFICE (China)  
[www.optexchina.com](http://www.optexchina.com)